

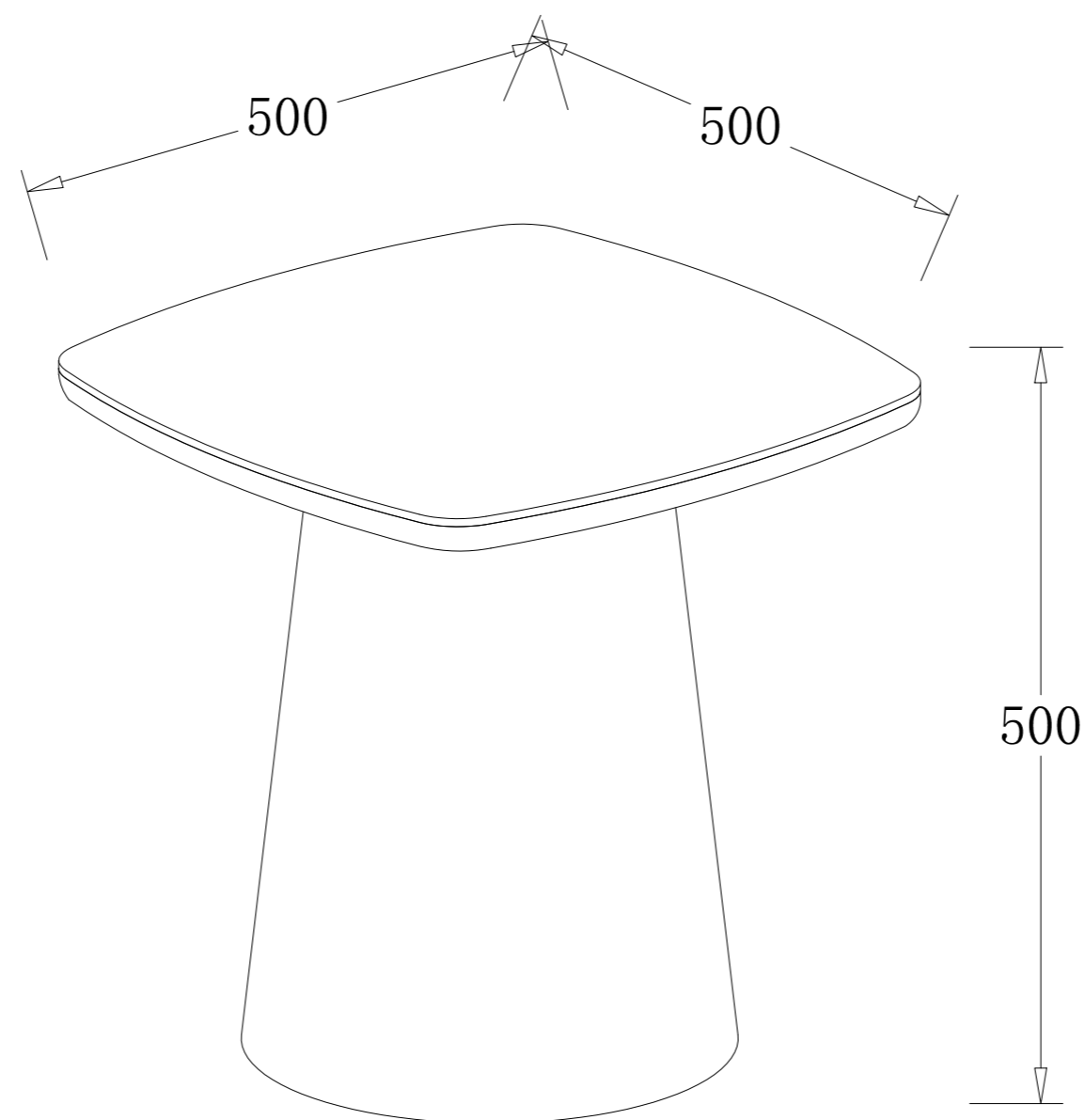

ASSEMBLY INSTRUCTION
DORVAL LAMP TABLE
ITEM CODE 82819



Imported by Amart Furniture Pty Ltd. Qld. Brisbane Australia.
For any assistance with assembly or for missing parts please phone Amart Furniture
Customer Service Free call 1800 351 084

PRE-ASSEMBLY PREPARATION

Before you start:

1. Choose a clean, level, spacious assembly area. Avoid hard surfaces that may damage the product
2. Take care when lifting. Product should be assembled as near as possible to the point of use
3. Ensure that you have all required contents for complete assembly.
4. Always read the assembly instructions carefully before beginning assembly.
5. Keep all hardware parts and packaging out of reach of small children.
6. Do not over tighten the screws and bolts as this may damage the threads

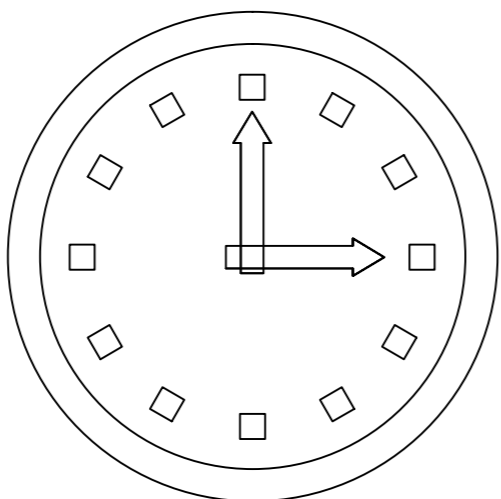
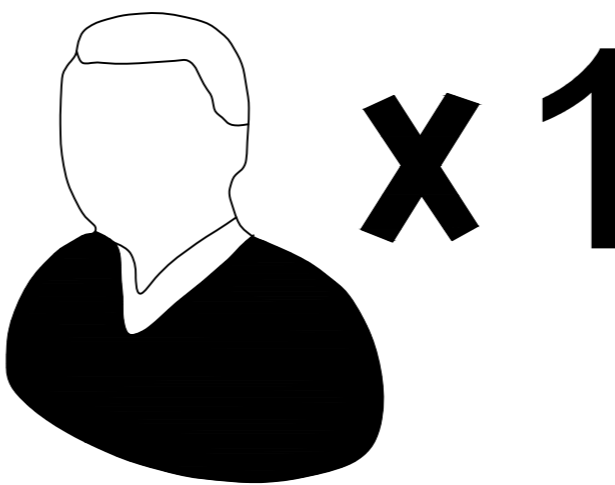

 <p>ALLOW 15 MINUTES</p>	 <p>1 PEOPLE REQUIRED</p>
---	--

⚠ WARNING		
		<p>Children have died from furniture tipover.</p> <ul style="list-style-type: none">• ALWAYS secure it with an anchor device.• NEVER allow children to stand, climb or hang on drawers, doors, or shelves.• NEVER open more than one drawer at a time.• Place heavy items down low <p>NEVER put a TV on this furniture </p> <p>This is a permanent label. Do not remove!</p>

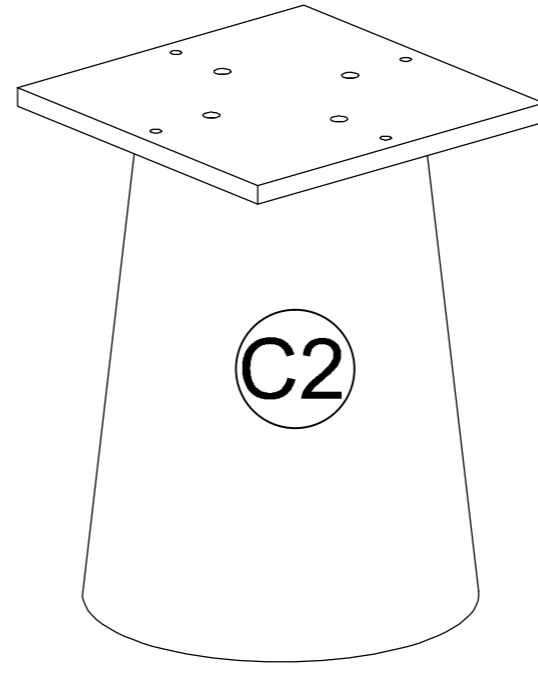
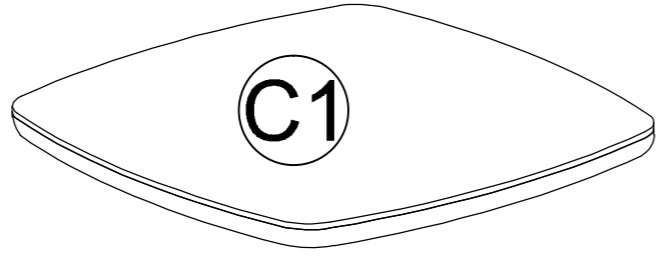
PARTS LIST

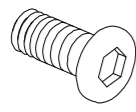
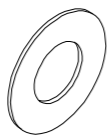

C1	Table Top
C2	Table Base

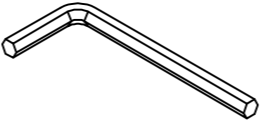
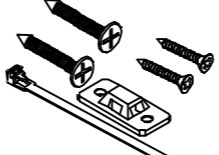
<input type="checkbox"/> A. Bolt M8x35  4PCS	<input type="checkbox"/> B. Washer Ø16  4PCS	<input type="checkbox"/> C. Protect foam Ø35X5mm  6PCS	<input type="checkbox"/> D. Hex Key 5MM  1PCE	<input type="checkbox"/> E. Safety Bracket Kit  2PCS
---	---	---	---	---

Step 1: Attach Protect Foam(C) to Table Base(C2).

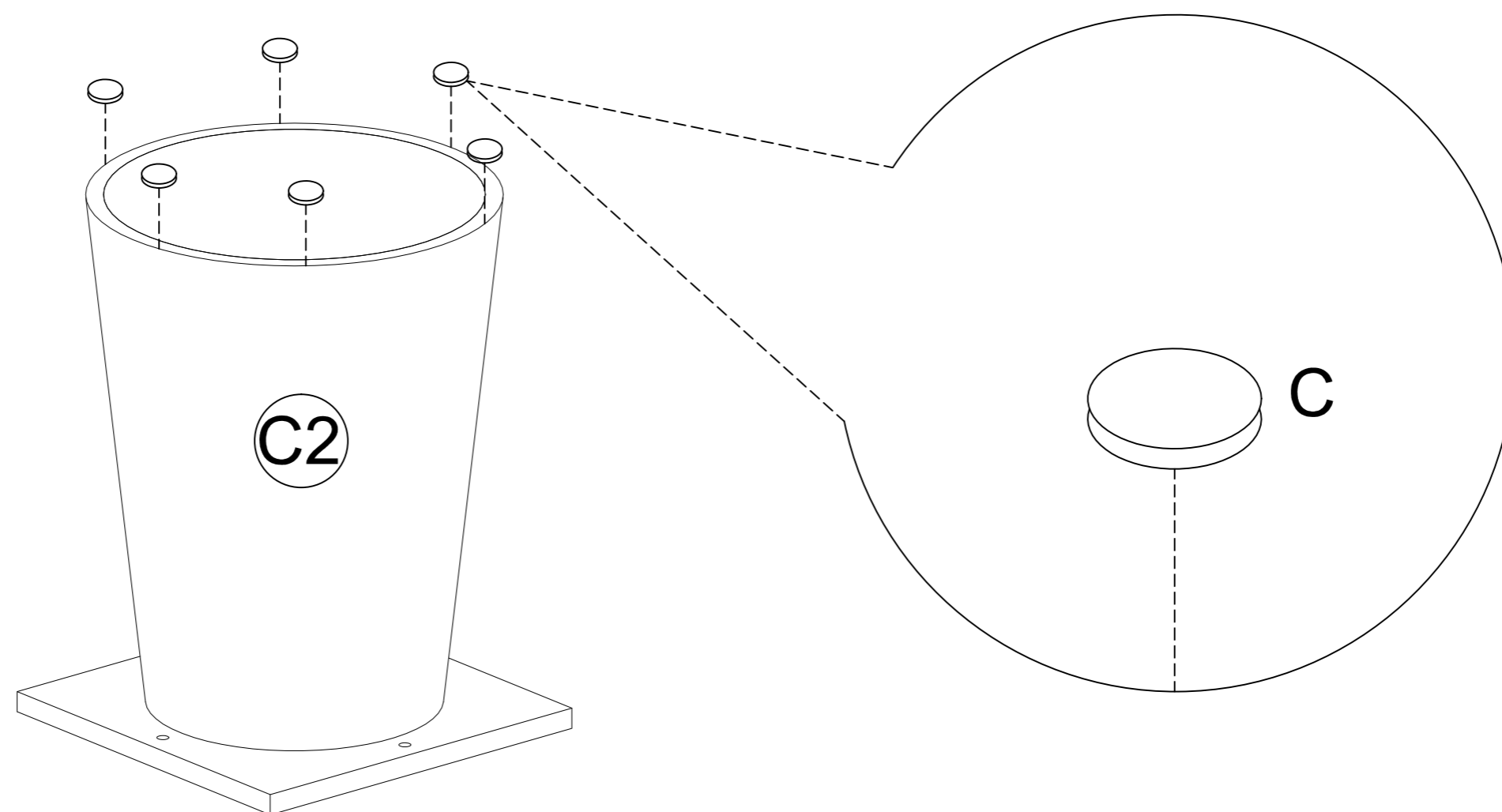

Step 2: Use Hex Key(D) to attach Table Top(C1) to Table Base(C2) with Bolt(A) and Washer(B).

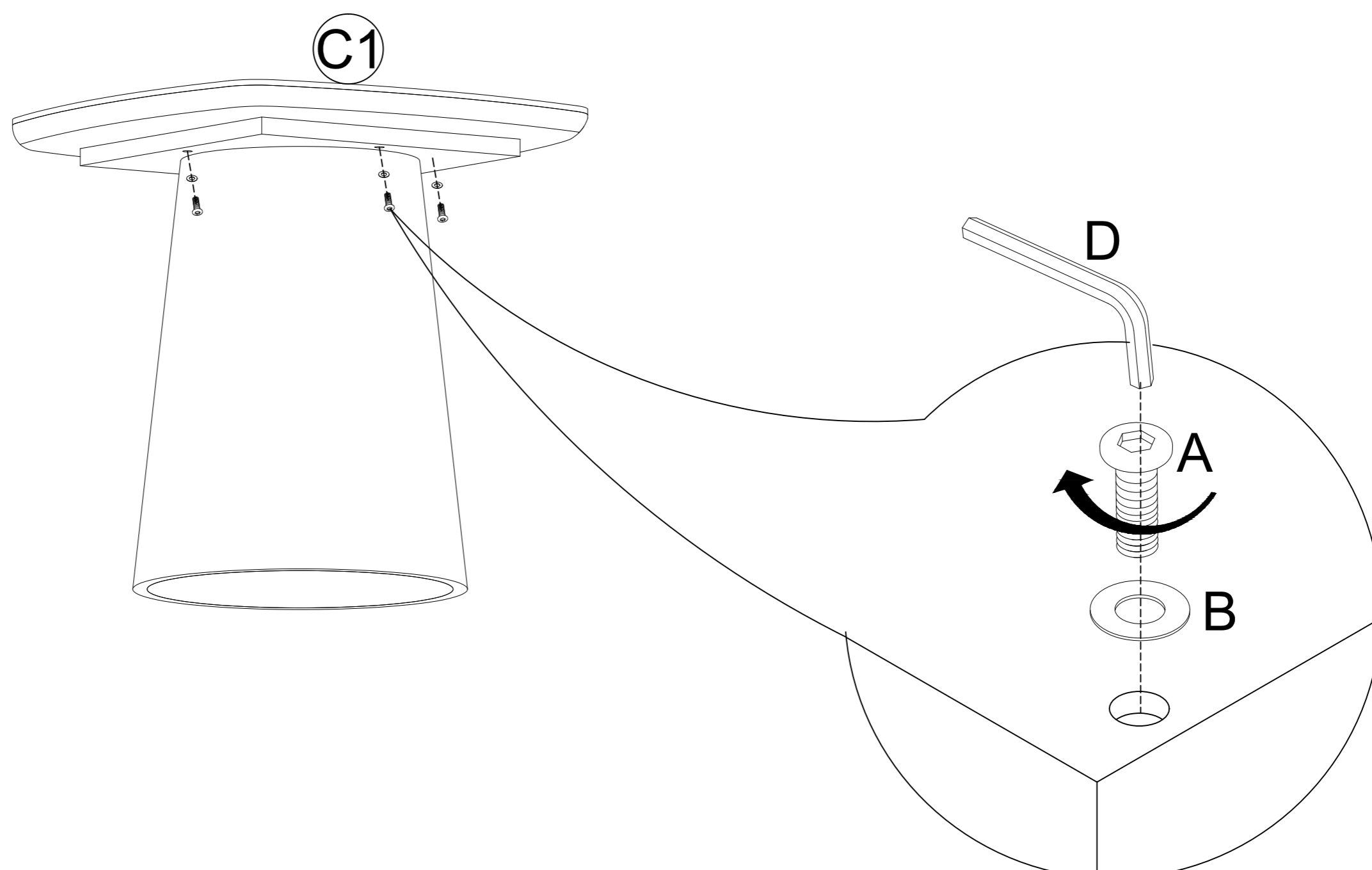

Assembly is complete.

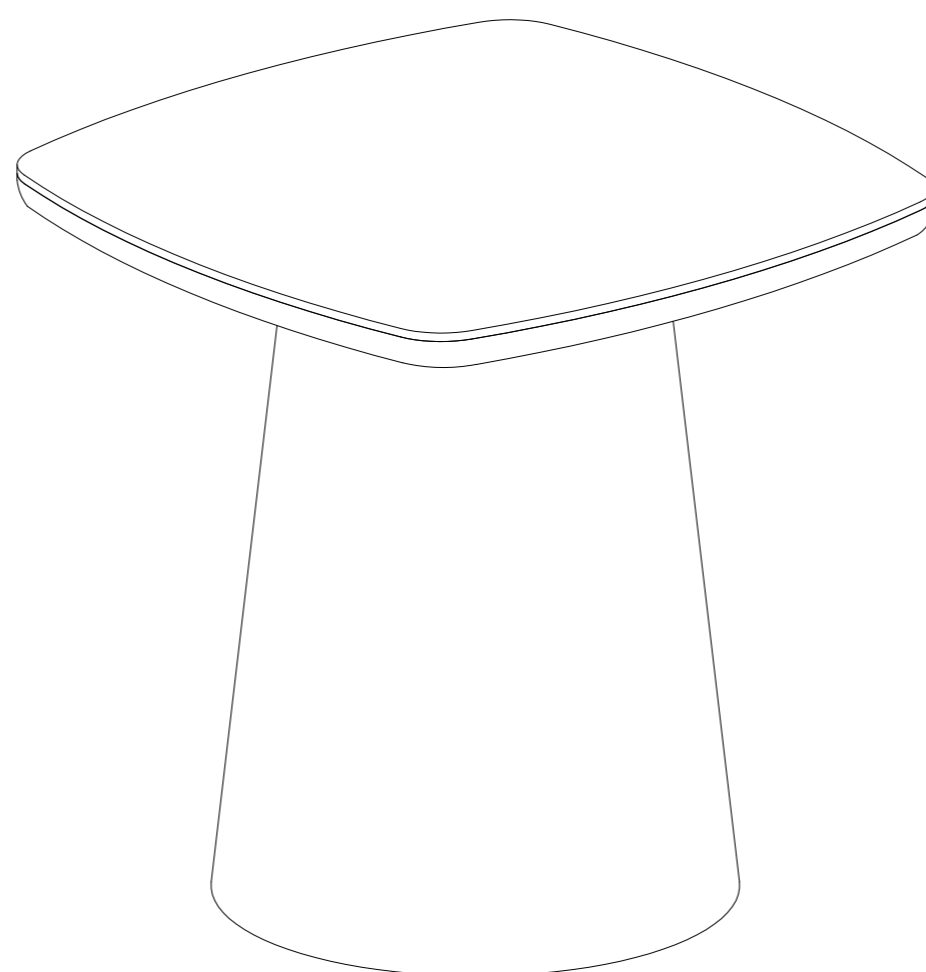

DO NOT PUSH OR DRAG THIS TABLE-In doing so, damage may be caused to the base.
Do not sit or lean on the edge of the table. By doing so the table may tip to one side.

SAFETY BRACKETS INSTRUCTIONS

This furniture poses a tipping risk and as such must be secured to a wall using the provided tipping kit.

1. Attach one Mounting Plate to the wall with the Large Screws. Make sure to attach the Mounting Plate into a stud. If mounting into brick or masonry you will need to acquire wall anchors. Please enquire with your local hardware supplier for appropriate fixings.
2. Attach the second Mounting Plate to the furniture frame with the Short Screws.
3. Move the furniture to its final position. Thread a Wall Strap through the both Mounting Plates and tighten until snug. Do not over tighten.
4. Make sure that the Mounting Plates are firmly attached to the wall and furniture and that the Wall Strap is snug.

HARDWARE



Mounting Plate x 2



Wall Strap x 1



Large Screw x2



Small Screw x2

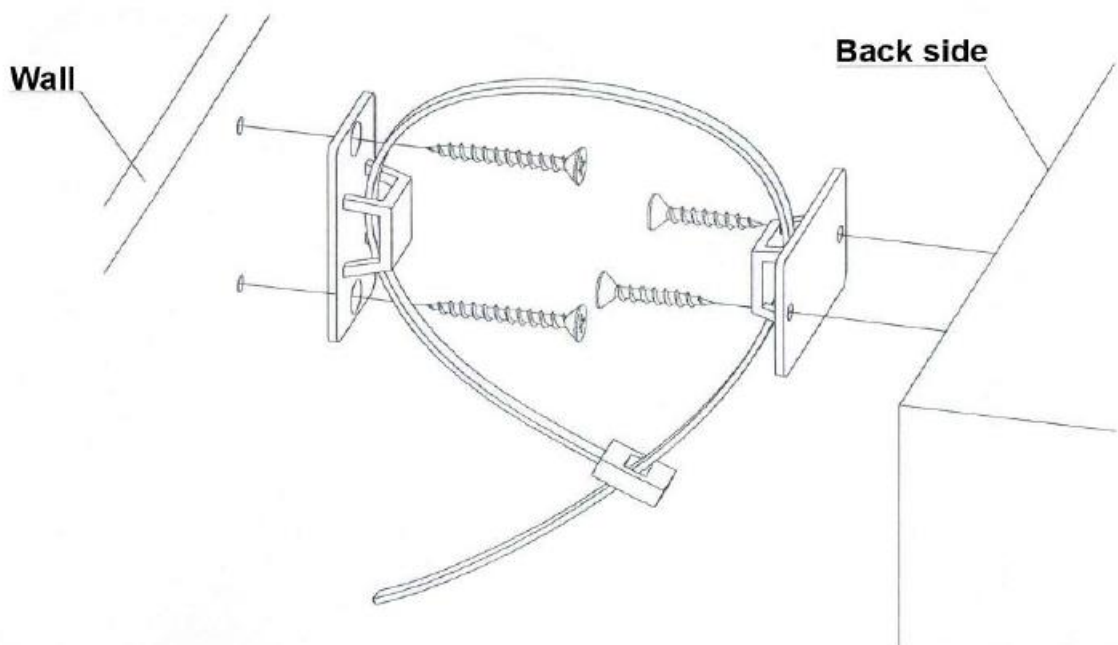

IMPORTANT: CARE GUIDE FOR YOUR HI-GLOSS FURNITURE

Congratulations! You have just purchased a quality product from Amart Furniture, Australia's largest discount furniture retail store. Please read on for important information regarding your purchase...

Hi-gloss lacquered furniture is more sensitive to marks and scratching than some other furniture products. It is important to exercise caution and care to maximise the life and beauty of this product.

Following the below simple guidelines when using your hi-gloss product will protect your investment for years to come:

- Dust frequently with a clean damp, lint-free cloth. This will help remove abrasive build up which can damage a finish over time.
- Avoid using chemicals or solvents when cleaning the product.
- Do not place hot objects on any furniture surface. Always use a hot plate or placemat. Lacquer finishes provide added scratch and heat resistance to our furniture, but they can still be damaged without proper care.
- Avoid exposing your furniture to strong sunlight. Prolonged exposure to direct sunlight can fade the finish of your furniture.
- Do not expose your furniture to any liquids. Avoid allowing water to sit on your furniture. Alcohol, nail polish and perfume are particularly harmful as they will dissolve the lacquer finish on contact.
- Do not allow plastic to come in direct contact with your furniture. Chemicals in the plastic of some placemats etc may soften and mark the finish if left in contact with the furniture for a period of time.
- Avoid placing sharp or rough objects on the surface of your furniture. These may scratch the surface of the product.
- When moving your furniture, do not drag it across the floor. This may damage the product. Instead use two people to lift carefully with caution from either end.

